



OUTDOOR FIRE PIT with pilot safety system

Model FBB-N,P (S)

OWNER'S OPERATION AND INSTALLATION MANUAL



We recommend that our products be installed and serviced by professionals who are certified in the U.S. by NFI (National Fireplace Institute).



Complies with ANS Z21.97.CSA 2.41-2012 "Outdoor Decorative Gas Appliances",

CGA 2.17-M91(R2009) "Gas Fired Appliances for Use at High Altitudes"

DANGER

If you smell gas:

1. Shut off gas to appliance.
2. Extinguish any open flame.
3. If odor continues, keep away from the appliance and immediately call your gas supplier or fire department.

WARNING

Improper installation, adjustment, alteration, service or maintenance can cause injury or property damage. Read the installation, operating and maintenance instructions thoroughly before installing or servicing this equipment.

WARNING

Do not store or use gasoline or other flammable vapors and liquids in the vicinity of this or any other appliance.

An LP-cylinder not connected for use shall not be stored in the vicinity of this or any other appliance.

DANGER



CARBON MONOXIDE HAZARD

This appliance can produce carbon monoxide which has no odor. Using it in an enclosed space can kill you. Never use this appliance in an enclosed space as a camper, tent, car or home

WARNING: For Outdoor Use Only

INSTALLER: Leave this manual with the appliance. **CONSUMER:** Retain this manual for future reference.

Version française de ce manuel est disponible à partir du site WEB : www.woodbridgefp.com

French version of this Owners Manual is available at www.woodbridgefp.com

SAFETY INFORMATION



WARNINGS

IMPORTANT: The appliance should be inspected before use and at least annually by a qualified service person. More frequent cleaning may be required as necessary. It is imperative that the control compartment, burners and circulating air passageways of the appliance be kept clean.

⚠ DANGER: Carbon monoxide poisoning may lead to death!

Carbon Monoxide Poisoning: Early signs of carbon monoxide poisoning resemble the flu, with headaches, dizziness, or nausea. If you have these signs, the Fire Pit may not be working properly.

Get fresh air at once! Have the Fire Pit serviced. Some people are more affected by carbon monoxide than others. These include pregnant women, people with heart or lung disease or anemia, those under the influence of alcohol, and those at high altitudes.

Natural Gas: Natural gas is odorless. An odor making agent is added to the gas. The odor helps you detect a gas leak. However, the odor added to the gas can fade. Gas may be present even though no odor exists.

Make certain you read and understand all warnings. Keep this

manual for reference. It is your guide to safe and proper operation of this appliance.

⚠ WARNING: Any change to this appliance or its controls can be dangerous.

1. This appliance, as supplied, is only for use with the type of gas indicated on the rating plate.
2. When an appliance is for connection to a fixed piping system, the installation must conform with local codes, or in the absence of local codes with the *National Fuel Gas Code, ANSI Z223.1/NFPA 54, or International Fuel Gas Code.*
3. Keep the appliance area clear and free from combustible materials, gasoline and other flammable vapors and liquids.
4. Do not burn solid fuel in the fireplace after installing the appliance. Do not use this appliance to cook food or burn paper or other objects.
5. **Children and adults should be alerted to the hazards of high surface temperatures and should stay away to avoid burns or clothing ignition.**
6. **Clothing or other flammable materials should not be hung from the appliance, or placed on or near the appliance.**
7. **Young children should be carefully supervised when they are in the area of the appliance.**
8. The appliance, when installed, must be electrically grounded in accordance with local codes or, in the absence of local codes, with the *National Electrical Code, ANSI/NFPA 70.*
9. **Do not use appliance if any part has been under water. Immediately call a qualified service technician to inspect the room appliance and to replace any part of the control system and any gas control which has been under water.**
10. Inspect the burner before each use of Outdoor Fire Pit. The burner must be replaced prior to the appliance being put into operation if it is evident that the burner is damaged.
11. Turn the appliance off and let cool before servicing, installing, or repairing. **Any guard or other protective device removed for servicing the appliance must be replaced prior to operating the appliance.** Only a qualified service person should install, service, or repair appliance.

HIGH ALTITUDE INSTALLATIONS:

The appliance is rated for installations up to 4500' (1372 m) above sea level. Above 4500' the appliance must be de-rated at the factory for the appropriate altitude.

LOCAL CODES

Install and use Outdoor Fire Pit with care. Follow local codes.

In the absence of local codes, use the latest edition of *The National Fuel Gas Code ANSI Z223.1/NFPA 54* available from:

- * American National Standards Institute, Inc., 1430 Broadway, New York, NY 10018
- * National Fire Protection Association, Inc., Batterymarch Park, Quincy, MA 02269.

PRODUCT ASSEMBLY

WARNING: Failure to position the parts in accordance with these diagrams or failure to use only parts specially approved with this appliance may result in property damage or personal injury.

1. Remove Burner Assembly, and Burner Media from packaging (see **Parts List**)
2. Connect the Burner Assembly to gas supply using supplied flex connector and shutoff valve.
3. Evenly fill the media compartment with burner media (broken tempered glass) fully covering the burner as shown on a picture.
If you are NOT planning to add optional topping media, then fill the media compartment in full and proceed to the step 5.



4. Place and evenly distribute topping media (optional logs or stones) on top of burner media as shown on a picture.



5. Carefully leak test all connections following the procedure on Page 5.

6. Having free access to the valve light the appliance following the procedure on Page 7.



Make sure the flame is even along the burner and appliance is fully operational and safe for use. Turn OFF the appliance and let it cool.

INSTALLATION

CAUTION: Do not remove the metal data plates attached to the Linear Burner System. These plates contain important information.

NOTICE: Installation and repair should be done by a qualified service person. The appliance should be inspected before use and at least annually by a qualified service person. More frequent cleaning may be required as necessary. It is imperative that control compartment, burner and circulating air passageways of the appliance be kept clean.

CLEARANCES TO COMBUSTIBLE MATERIALS:

- Top 72" (183 cm)
- Sides 14" (36 cm)
- Floor 4" (10 cm)

FUEL PRESSURE SPECIFICATION:

- Inlet Natural Gas (NG) Min 5.0" W.C.
Max 10.5" W.C.
- Inlet Propane (LP) Min 11.0" W.C.
Max 13.0" W.C.
- Manifold Natural Gas (NG) 4.0" W.C.
- Manifold Propane (LP) 10.0" W.C.

FIRE PIT INSTALLATION (EXAMPLES)

Clearance to combustibles must be maintained according to Page 3.



Non-combustible materials only

CONNECTING TO GAS SUPPLY

⚠ WARNING: A qualified service person must connect appliance to gas supply. Follow all local codes.

Installation Items Needed

Before installing the Outdoor Fire Feature, make sure you have all items listed below:

- piping (check local codes)
- sealant
- manual shutoff valve
- adjustable (crescent) wrench or pliers
- sediment trap
- tee joints
- pipe wrench

⚠ CAUTION: Use only new, black iron or steel pipe. Internally tinned copper tubing may be used in certain areas. Use pipe of 1/2" diameter or greater to allow proper gas volume to Linear Burner System. If pipe is too small, undue loss of pressure will occur.

Installation must include a manual shutoff valve, union, and plugged 1/8" NPT tap. Locate NPT tap within reach for test gauge hook up. NPT tap must be upstream from the appliance.

Apply pipe joint sealant lightly to male threads. This will prevent excess sealant from going into pipe. Excess sealant in pipe could result in a clogged burner injector.

Install sediment trap in supply line as shown below. Locate sediment trap where it is within reach for cleaning and trapped matter is not likely to freeze. A sediment trap

traps moisture and contaminants. This keeps them from going into Outdoor Fire Pit controls.

If sediment trap is not installed or is installed wrong, unit may not run properly.

CHECKING GAS CONNECTION

⚠ WARNING: Test all gas piping and connections for leaks after installing or servicing. Correct all leaks at once.

⚠ WARNING: Never use an open flame to check for a leak. Apply a mixture of liquid soap and water on all joints. Bubbles forming show a leak. Correct all leaks at once.

Test Pressures in Excess Of 1/2 psi (3.5 kPa)

The appliance and its individual shutoff valve must be disconnected from the gas supply piping system during any pressure testing of that system at test pressures in excess of 1/2 psi (3.5 kPa).

Test Pressures Equal To or Less Than 1/2 psi (3.5 kPa)

The appliance must be isolated from the gas supply piping system by closing its individual manual shutoff valve during any pressure testing of the gas supply piping system at test pressures equal to or less than 1/2 psi (3.5 kPa).

Approved Flexible Gas Hose



A.G.A. Design-Certified Manual Shutoff Valve With 1/8" NPT Tap

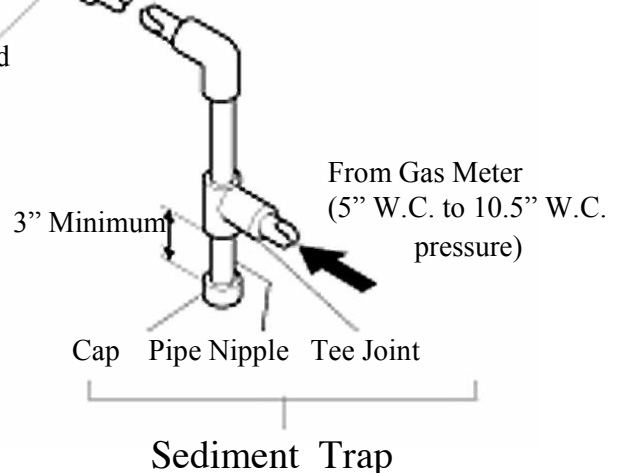

OUTDOOR FIRE PIT

DIMENSIONS

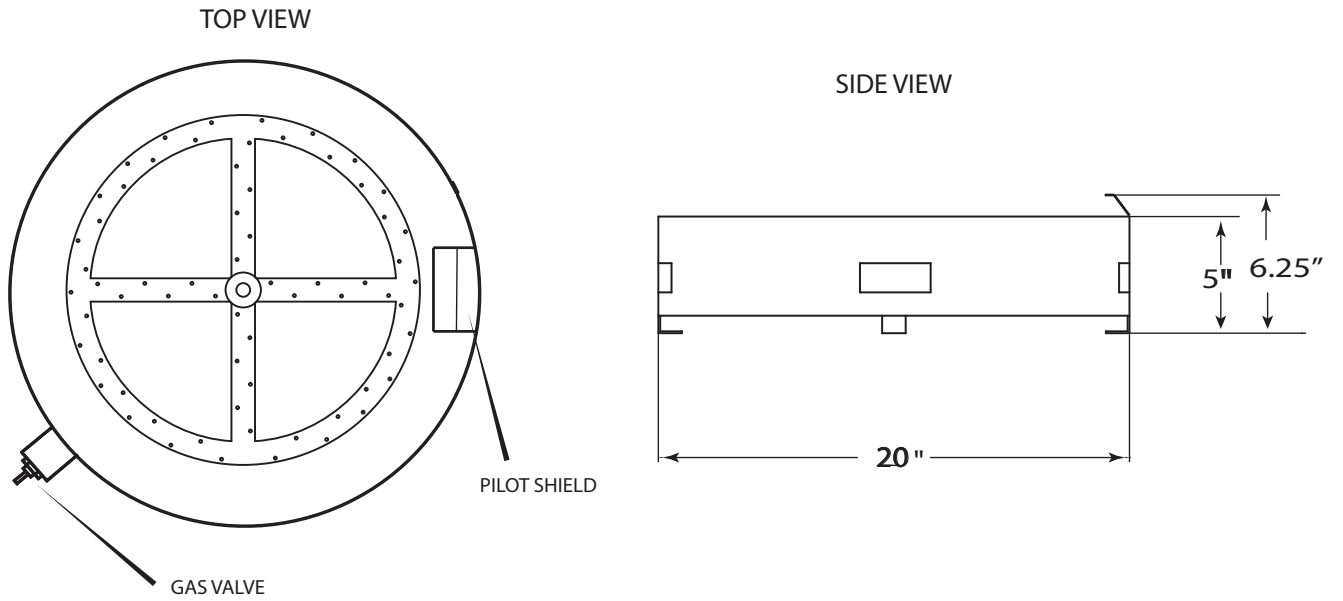

MODEL #	GAS TYPE	INPUT RATE (BTU/h)	ORIFICE SIZE	BURNER PORTS	PORT SIZE
FBB - N	NATURAL	60,000	28	66	1/8"
FBB - P	PROPANE	54,000	43	66	1/8"

LIGHTING INSTRUCTION

FOR YOUR SAFETY READ BEFORE LIGHTING

WARNING

If you do not follow these instructions exactly, a fire or explosion may result causing property damage, personal injury or loss of life.

- A. This appliance is equipped with a pilot which must be lit by hand while following these instructions exactly.
- B. BEFORE OPERATING smell all around the appliance area for gas. Be sure to smell next to the floor because some gas is heavier than air and will settle on the floor.

WHAT TO DO IF YOU SMELL GAS:

- Do not try to light any appliance.
 - Do not touch any electric switch; do not use any phone in your building.
 - Immediately call your gas supplier from a neighbor's phone.
Follow the gas supplier's instructions.
 - If you cannot reach your gas supplier, call the fire department.
- C. Use only your hand to push in, or turn the gas control knob. Never use tools. If the knob will not push in or turn by hand, don't try to repair it. Call a qualified service technician. Force or attempted repair may result in a fire or explosion.
 - D. Do not use this appliance if any part of it has been under water. Immediately call a qualified service technician to inspect the appliance and to replace any part of the control system and any gas control that has been under water.

LIGHTING PILOT FOR THE FIRST TIME

INITIAL LIGHTING

Purge air from the supply line as follows:

- Open main shutoff valve.
- Unscrew main pressure test point.
- Leave inlet test screw open until gas comes in.
- When gas is flowing, tighten inlet screw immediately.

DANGER

Never use an open flame to check for gas leak.

LEAK TESTING

1. Follow the pipe from the gas supply line connection to the gas valve. Check connection for leaks with soap and water mixture.
2. Next check for gas leaks at the burner with soap and water mixture.
3. Check the pilot for gas leaks with soap and water mixture.

LIGHTING PILOT FOR THE FIRST TIME

APPROVED LEAK TESTING METHOD

You may check for gas leaks with the following methods only:

- Soap and water solution
- An approved leak testing spray
- Electronic sniffer

DANGER

Never use an open flame to check for gas leak.

WARNING

If using a soap and water solution to test for leaks, DO NOT spray solution onto control body.

NOTE: Remove any excessive pipe compound from the connections. Excessive pipe compound can set off electronic sniffers.

Check for gas leaks in each of the following locations:

- Pipe from the gas supply line connection to the gas valve
- Burner connections, pilot
- All joints on valve and control body
- Field made joints / gas shutoff valve
- Factory made joints, each joint and connection

LIGHTING INSTRUCTIONS

1. **STOP!** Read the safety information on previous page.
2. Turn the gas control knob to the "OFF" position.
3. Wait five (5) minutes to clear out any gas. If you then smell gas, STOP! Follow "B" in the safety information on the previous page. If you don't smell gas, go to the next step.
4. Locate the Pilot Assembly on the top surface of the Fire Pit

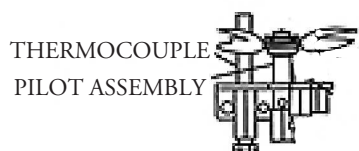

Knob at Pilot Position



6. Depress and turn pilot gas knob counterclockwise to "PILOT" position.
7. Depress fully and hold pilot gas knob.
Light pilot with a match or barbeque lighter.
Keep knob fully depressed for a few seconds. Release and check that pilot continues to burn.
 - If the pilot does not stay lit, repeat steps 1 and 2.
 - If the pilot knob does not pop up when released, STOP and immediately call service technician or gas supplier
 - If the pilot will not stay lit after several tries, turn the gas control knob to "OFF" position and call your service technician or gas supplier.

LIGHTING BURNER

LIGHTING THE BURNER

Depress and turn the knob counterclockwise  to the "ON" position.
It will take less than four (4) seconds for the burner to ignite.



On Position

PILOT POSITION

Depress and turn knob to pilot position to keep burner off while maintaining the pilot light.



Pilot Position

TO TURN OFF GAS TO APPLIANCE

1. Depress and turn knob clockwise  to "OFF" position.

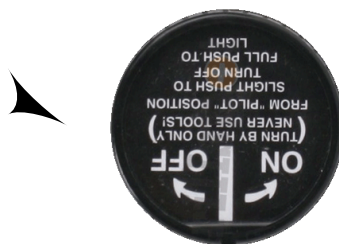

Off Position

TROUBLESHOOTING

⚠ WARNING: Turn off Fireribbon and let cool before servicing. Only a qualified service person should service and repair this appliance.

Note: All troubleshooting items are listed in order of operation.

OBSERVED PROBLEM	POSSIBLE CAUSE	REMEDY
Unit is smoking / sooting excessively <i>(Note: It is natural and unavoidable for appliance sets to produce moderate levels of carbon (soot) where flames contact the media. This is especially true with propane/LP gas.)</i>	<ol style="list-style-type: none"> 1. Poor fuel quality 2. Fireplace venting system not drafting properly 3. Excessive flame impingement or blockage 4. Improper fuel/air mixture 5. Excessive gas supply/pressure 6. Not enough media over burner tube 	<ol style="list-style-type: none"> 1. Contact local natural or propane/LP gas company 2. Adjust damper wide open and/or have fireplace and venting professionally cleaned and checked 3. Separate the stones to allow more flame passage 4. Remove any foreign items from the flame pattern and/or check for proper orifice sizing 5. Preheat flue in very cold weather 6. Make sure the burner tube is completely covered with glass media
Burner is excessively noisy <i>(Note: The movement and combustion of gas will create low, unavoidable levels of noise.)</i>	<ol style="list-style-type: none"> 1. Passage of air/gas across irregular surfaces 2. Excessive gas pressure on natural gas units 	<ol style="list-style-type: none"> 1. Relieve any tight bends or kinks in gas supply line 2. Check/reset gas regulator pressure
Burner flame is too low or too high	<ol style="list-style-type: none"> 1. Incorrect gas supply or pressure 2. Blocked burner orifice or burner manifold ports 3. Improper burner orifice size 	<ol style="list-style-type: none"> 1. Check for proper gas supply pressure 2. Free burner orifice and manifold ports of any burrs, paint, or other blockage 3. Verify proper burner orifice sizing (see page 6)

OBSERVED PROBLEM**POSSIBLE CAUSE****REMEDY**

IMPORTANT: Operating unit where impurities in air exist may create odors. Cleaning supplies, paint, paint remover, cigarette smoke, cements and glues, new carpet or textiles, etc., create fumes. These fumes may mix with combustion air and create odors. These odors will disappear over time.

**WARNING: If you smell gas**

- Shut off gas supply.
- Do not try to light any appliance.
- Do not touch any electrical switch; do not use any phone in your building.
- Immediately call your gas supplier from a neighbor's phone. Follow the gas supplier's instructions.
- If you cannot reach your gas supplier, call the fire department.

Pilot lights but flame goes out when control knob is released

1. Control knob not fully pressed in
2. Control knob not pressed in long enough
3. Manual shutoff valve not fully open
4. Pilot flame not touching thermocouple, which allows thermocouple to cool, causing pilot flame to go out. This problem could be caused by one or both of the following:
 - A) Low gas pressure
 - B) Dirty or partially clogged pilot
5. Thermocouple connection loose at control valve
6. Thermocouple damaged
7. Control valve damaged

1. Press in control knob fully
2. After pilot lights, keep control knob pressed in 30 seconds
3. Fully open manual shut-off valve
4. A) Contact local natural gas company
B) Clean pilot (see *Cleaning and Maintenance*, page 10) or replace pilot assembly
5. Hand tighten until snug, then tighten 1/4 turn more
6. Replace thermocouple
7. Replace control valve

Burner does not light after pilot is lit

1. Burner orifice clogged
2. Inlet gas pressure is too low
3. Burner orifice diameter is too small
4. Thermopile leads disconnected or improperly connected

1. Clean burner orifice
2. Contact local natural or propane/LP gas company
3. Replace burner orifice
4. Reconnect leads

Delayed ignition burner

1. Pilot flame needs adjusting

1. Adjust pilot flame for approximately "blue flame"

Continued

OBSERVED PROBLEM	POSSIBLE CAUSE	REMEDY
Fire Pit produces unwanted odors	1. Gas leak.	1. Locate and correct all leaks (see <i>Checking Gas Connections</i> , page 5)
Gas odor even when control knob is in OFF position	1. Gas leak. 2. Control valve defective	1. Locate and correct all leaks (see <i>Checking Gas Connections</i> , page 5) 2. Replace control valve

CLEANING AND MAINTENANCE

WARNING

Turn off gas before servicing Firepit. It is recommended that a qualified service technician perform these check-ups at the beginning of each heating season.

BURNER

Keep the control clean by vacuuming or brushing at least twice a year. Make sure the burner porting and burner air openings are free of obstructions at all times.

Inspect area around the burner. Remove any lint or foreign material with a brush or vacuum cleaner.

The flame from the burner should be visually checked as soon as the unit is installed and periodically during normal operation.

The burner must be replaced prior to the appliance being put into operation if it is evident that the burner is damaged.



NORMAL FLAME

PILOT FLAME

The flames from the pilot should be visually checked as soon as the unit is installed and periodically during normal operation. **The pilot flame must always be present when the Fire Pit is in operation.** The pilot flame has two distinct flames, one engulfing the flame sensor and the other reaching to the main burner.

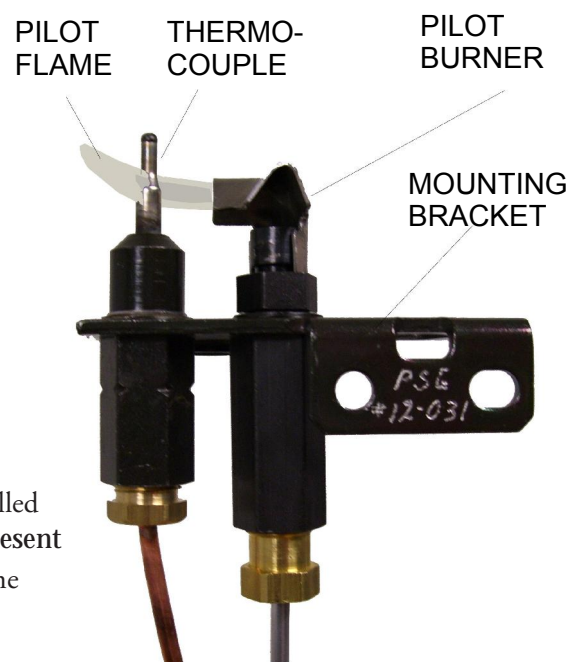

ILLUSTRATED PARTS LIST

FOR PART DESCRIPTION SEE NEXT PAGE

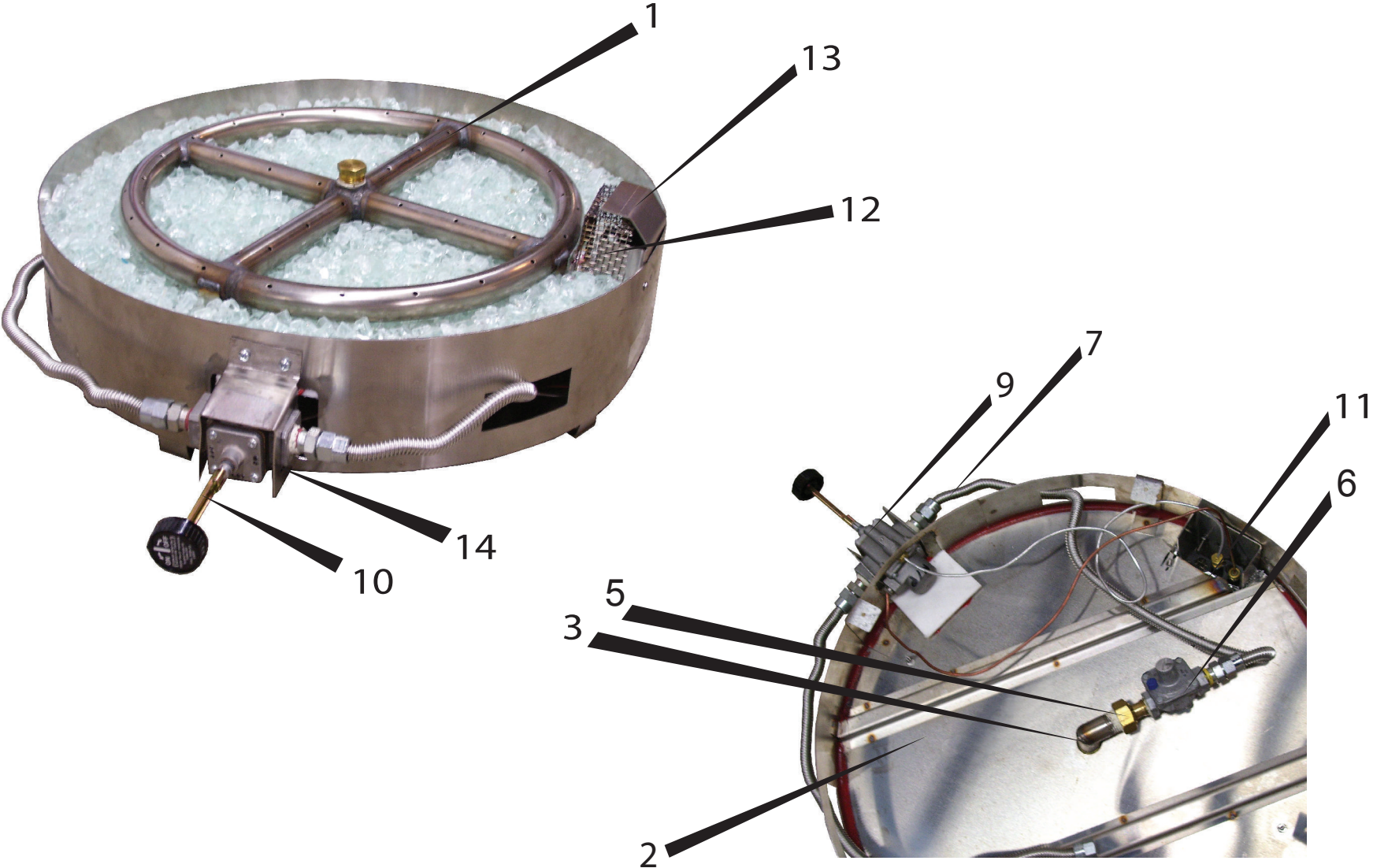

ILLUSTRATED PARTS LIST (Continued)

FOR PART DESCRIPTION SEE NEXT PAGE

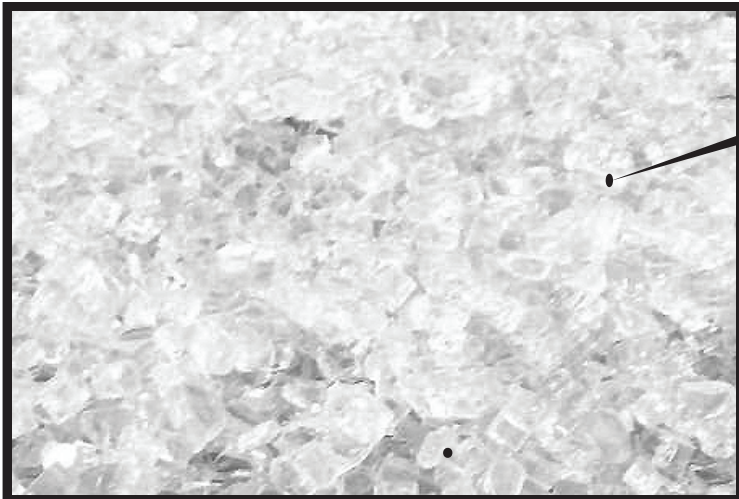

15

BURNER GLASS MEDIA



16

OPTIONAL STONES



17

2 PCS



19

1 PC



18

2 PCS



1 PC

20

OPTIONAL LOG SET

WARNING

Failure to position the parts in accordance with these diagrams or failure to use only parts specifically approved with this appliance may result in property damage or personal injury.

REPLACEMENT PARTS ARE AVAILABLE THROUGH YOUR RETAILER

Item	Description	QTY	FBB-N(S)	FBB-P(S)
			Natural	Propane
1	Burner Assembly	1	W600001	W600002
3	Elbow	1	H100036	H100036
2	Burner Tray	1	W600004	W600004
4	Reducer Bushing	1	H100007	H100007
5	Orifice	1	F200016	F200015
6	Pressure Regulator	1	F200110	F200111
7	Flex Connector	2	C100072	C100072
8	Shutoff Valve (NOT SHOWN)	1	F200066	F200066
9	Valve	1	R100023	R100023
10	Valve Stem Extender	1	R100024	R100024
11	Pilot	1	R100033	R100034
12	Pilot Screen	1	F100101	F100101
13	Pilot Shield	1	F100100	F100100
14	Bracket	1	F100102	F100102
15	Glass Media (standard)	1	G100048	G100048
16	Stones (optional)	1	G100049	G100049
	LOG SET (optional)	1	M100503	M100503
17	Log #1	2		
18	Log #2	2		
19	Log #3	1		
20	Log #4	1		

WARRANTY INFORMATION

KEEP THIS FOR WARRANTY

Model _____
Serial No. _____
Date Purchased _____

Always specify model and serial numbers when communicating with the factory.

LIMITED LIFETIME WARRANTY

The following components are warranted for life to the original owner, subject to proof of purchase: Fire Pit.

BASIC WARRANTY

Woodbridge Fireplace Inc. warrants the components and materials in your appliance to be free from manufacturing and material defects for a period of two years from date of installation. After installation, if any of the components manufactured by Woodbridge Fireplace in the appliance are found to be defective in materials or workmanship, Woodbridge Fireplace will, at its option, replace or repair the defective components at no charge to the original owner. Woodbridge Fireplace will also pay for reasonable labor cost incurred in replacing or repairing such components for a period of two years from date of installation. Any products presented for warranty repair must be accompanied by a dated proof of purchase.

This Limited Lifetime Warranty will be void if the appliance is not installed by a qualified installer in accordance with installation instructions. The Limited Lifetime Warranty will also be void if the appliance is not operated and maintained according to the operating instructions supplied with the appliance, and does not extend to (1) firepit burner assembly damaged by accident, neglect, misuse, abuse, alterations, negligence of others, including the installation thereof by unqualified installers, (2) the costs of removal, reinstallation or transportation of defective parts on the appliance, or (3) incidental or consequential damage. All service work must be performed by an authorized service representative.

This warranty is expressly in lieu of other warranties, express or implied, including the warranty of merchantability of fitness for purpose and of all other obligations or liabilities. Woodbridge Fireplace does not assume for it any other obligations or liabilities in connection with sale or use of the appliance. In states that do not allow limitations on how long an implied warranty lasts, or do not allow exclusion of indirect damage, those limitations of exclusions may not apply to you. You may also have additional right not covered in the Limited Lifetime Warranty. Woodbridge Fireplace reserves the right to investigate any and all the claims against this Warranty and decide upon method of settlement. For information about this warranty contact:

Woodbridge Fireplace Inc.
1305 Meyerside Dr., Missisauga
Ontario, Canada L5T 1C9

Tel.: 1-905-564-3001

www.woodbridgefp.com